

IMPORTANT

PLEASE READ THESE INSTRUCTIONS BEFORE COMMENCING ASSEMBLY. Please retain this instruction sheet in your files. It contains important replacement parts information. All equipment must be installed in accordance with these instructions. It is important to use and maintain all public playground equipment properly. Playground equipment, which is improperly maintained, can cause serious injury. Periodical inspections, maintenance, repair and/or replacement of damaged parts is necessary for safe operation of equipment. Appropriate publications, available at no charge, from the consumer product safety commission, include "A Handbook for Public Playground safety". You can receive your free copy by calling 1-301-504-7908.

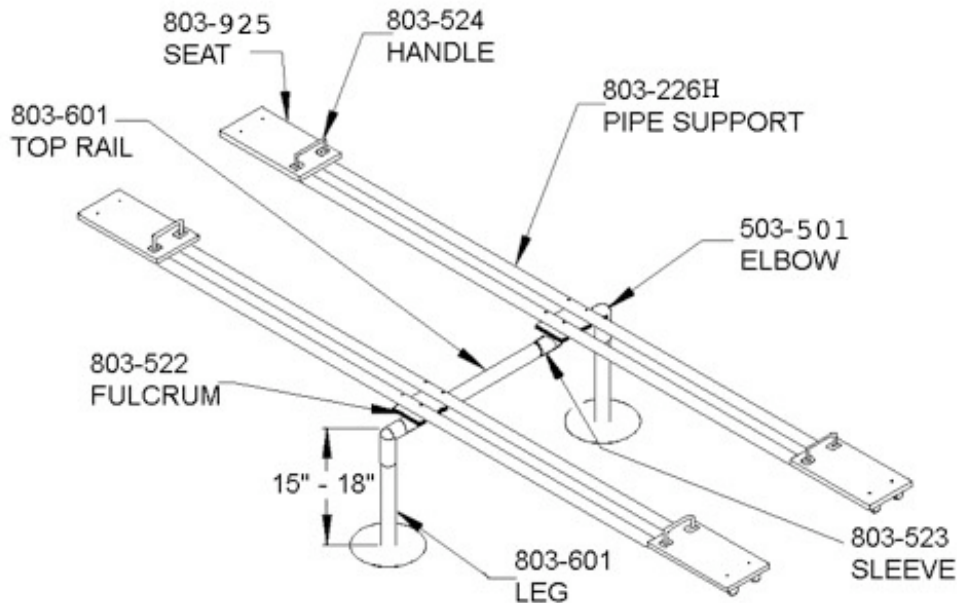

PACKING LIST

HARDWARE BAG

1	CTN	1	Hardware Bag	8	105-017	2	3/8" Pipe Plug
		2	503-501 Elbow	6	196-802	1	1/2" x 1/2" Socket Set Screw
		2	803-522 Fulcrum	16	116-550	5	5/16" x 3" B.H. Bolt
		2	803-523 Sleeve	8	116-543	5	5/16" x 2 1/4" B.H. Bolt
		4	803-524 Handle	24	326-501	5	5/16" Lock Washer
		4	803-925 Seat Boards	24	216-512	5	5/16" x 1" B.H. Nut
1	BDL	3	803-601 Pipe 2 3/8" OD x 3' 6" Long	1	416-400	1	1/4" Socket Key
4	PIPE	1	803-226H Pipe Supports	2	416-350	3	3/16" Socket Key
				1	516-350	1	Permabond Threadlocker Tube
				2	805-532	1	Warning Label
				2	805-534	2	SportsPlay Label
				1		1	Maintenance Checklist

1 CTN	1 BDL	4 PIPE	6 TOTAL PCS	200# Weight	Class 70
-------	-------	--------	-------------	-------------	----------

GENERAL USE/FALL ZONE & FOOTING RECOMMENDATIONS:

Stationary & portable equipment - use/fall zones should extend a minimum of 6 feet in all directions from the perimeter of the equipment ground space. This area should be covered with the required amount of resilient safety surfacing material. For some equipment - use/fall zones can overlap. See Consumer Product Safety Commission guidelines. Diameter & depth of footings illustrated are satisfactory in most applications for pipe sizes up to 2 3/8" diameter. Varying soil & climactic conditions may require deeper & heavier footings in some areas. Check local building codes.

DETAIL: Permanent Installation

Suggested Bracing Method

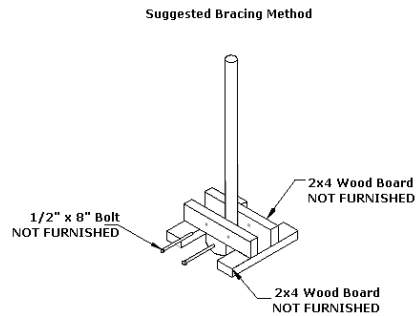
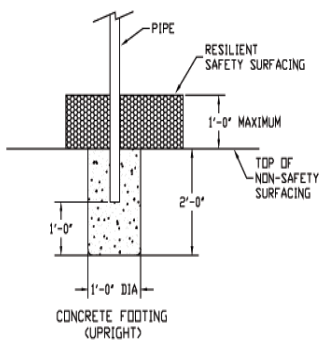

- If resilient surfacing is to be less than 12", then additional pipe should be put in concrete to maintain proper finish grade for equipment.

USE AREA & FOOTING:

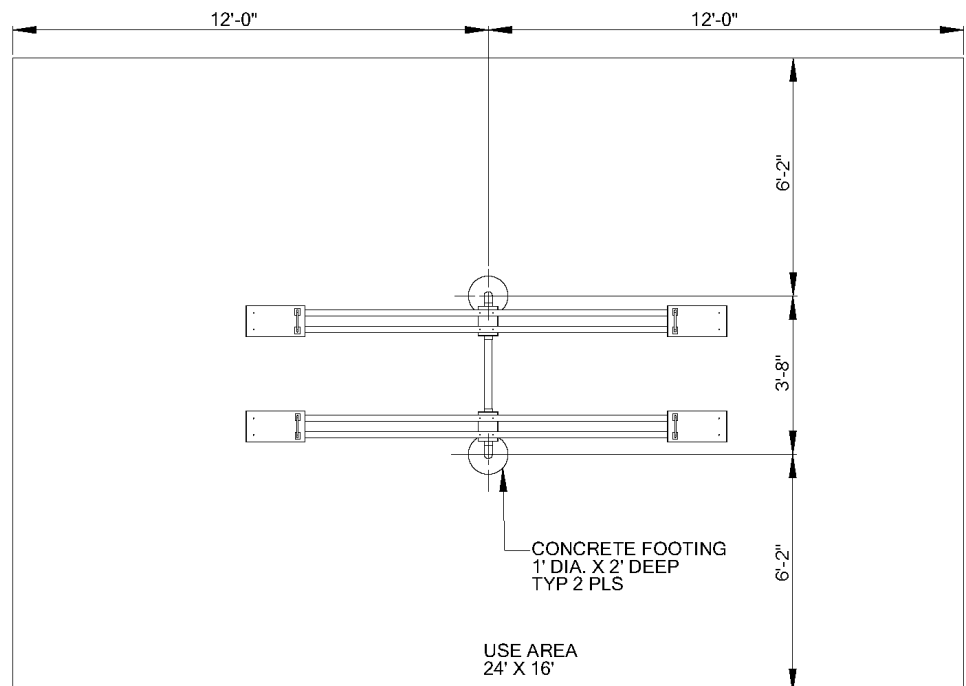

SPECIFIC INSTRUCTIONS:

Car tires (not furnished) or some other shock-absorbing material should be embedded in the ground beneath the seats to minimize the risk of injury due to abrupt contact with the ground. Also, lengths of standard 2 x 4's can be easily positioned between the pipe rails to prevent children from putting their feet between the rails.

GENERAL MAINTENANCE INSTRUCTIONS:

Check MONTHLY for loose bolts, damaged or broken parts. Tighten and/or replace immediately.

SPECIFIC ASSEMBLY AND INSTALLATION:

- NOTE:** All button head nuts are placed on the pipe side of the spots where attached and the lock washers are placed on the Bolts. DO NOT tighten nuts more than hand-tight until entire assembly is completed.
- STEP #1:** Assemble frame by first attaching one leg to top rail using elbow. Tighten set screws on elbow, slide fulcrum over top rail to elbow by leg. Slide sleeve on top rail so holds fulcrum in place. Tighten sleeve with set screw on bottom of top rail. Slide next sleeve onto top rail, then fulcrum, then attach elbow for second leg. Slide fulcrum back against elbow, then sleeve against fulcrum. Tighten sleeve with set screw. DO NOT attach see saws at this time.
- STEP #2:** Using assembled frame as your template, mark and dig footing holes.
- STEP #3:** Prop in holes, leaving 15-18" distance from resilient surface to top of frame, plumb, level and pour concrete. Allow at least 48 hours for concrete to harden.
- STEP #4:** After concrete has hardened, attach the rest of the equipment. Use the 5/16" x 2 1/4" button head bolts, lock washers and button head nuts to attach the long pipe supports to the fulcrums. Use the 5/16" x 3" button head bolts, lock washers and button head nuts (rear of seat) to attach the seat and handle to the pipe supports. Use Threadlocker on all button head fasteners. Drive pipe plugs into the open ends of the pipe supports.
- STEP #5:** Attach Warning Label and Manufacturer's Identification Label to a clean surface. The labels should be attached in a location where they are clearly visible and legible and away from normal hand and foot placement areas. The labels must be replaced if they become illegible, destroyed or are missing. Contact your SportsPlay distributor for replacement labels.