



Model # 940S-P6

WARRANTY & TERMS

WARRANTY: 5 Year Limited Warranty on Thermoplastic coated elements. Ultra Play guarantees all items for one full year to be free of defects in workmanship or materials when installed and maintained properly. We agree to repair or replace, any items determined to be defective. Items specifically not covered by this warranty include vandalism, man made or natural disasters, lack of maintenance, normal weathering or wear and tear due to public abuse.

ORDER INFORMATION: When ordering please include a brief description of all items. Be sure to include colors for UltraCoat and powder coated surfaces. To assist Ultra Play in entering orders properly, please fax or mail orders on your standard purchase order form. Quotes are good for 30 days.

GSA CONTRACT: GSA pricing is available on several items. Contact our sales department for specific information.

SPECIFICATIONS: Due to Ultra Play's continuous product improvement, we reserve the right to change specifications when necessary without notice.

PRICING: Ultra Play strives to keep pricing as low as possible. However, should we encounter increases in our costs that are simply too large to absorb, we reserve the right to increase prices without notice.

TERMS: Approved accounts net 30 days. Initial order requires payment in full before shipment. A finance charge of 1-1/2% per month will be applied to all delinquent accounts. We accept VISA, MASTERCARD, and AMERICAN EXPRESS.

FREIGHT CHARGES: Terms of sale are F.O.B. factory. Ultra Play will prepay and add the freight to the invoice if requested to do so. All weights are approximate.

Damages or loss in transit is the responsibility of the carrier, whether visible or concealed. It is the responsibility of the recipient to assure that the order is received complete. Before signing the delivery receipt, inspect the shipment immediately and completely. Note any damages or shortages on the bill of lading. Damage reports must be filed within 10 days. Ultra Play is NOT responsible for damages or loss in transit. Title to all goods passes to the customer at the time of shipment. Ultra Play will assist in filing claims if the freight arrangements were made by Ultra Play at your request.

CANCELLATIONS AND RETURNS: Cancellations are only accepted with approval of Ultra Play. No merchandise shall be returned without a Return Goods Authorization number which is issued by customer service. Any authorized merchandise must be carefully packed and received in saleable condition. A restocking charge of up to 25% will be applied to all returned goods when the error is not the fault of Ultra Play. All returns must be shipped freight prepaid.

SAFETY WARNINGS & EQUIPMENT INSPECTION

- Owners and installers please note these safety warnings and make use of this checklist on a regular basis.
- Follow installation instructions when erecting equipment.
- Ground surfaces around equipment should be restored as needed. Concrete footings should never be exposed. Surface depth should comply with ASTM and CPSC specifications.
- Check for and repair damage caused by wear or vandalism, a major factor in injury causing situations.
- All protruding bolts should be covered or cut off and finished smooth. Sharp edges on pipes should be capped or removed. Check for bent, broken, or severely worn pipe, and replace.
- All equipment should be free of rust and repainted whenever necessary to deter rusting.
- We provide our customers with layout sheets and installation instructions. Please keep on file the specifications sheet that contains the listing of every part used.
- Never add components not intended for use with this product.
- Regular maintenance is necessary in this and all park and recreational equipment to insure the safety of the user.
- Note: Proper maintenance of equipment requires regular tightening of all bolts, nuts, and setscrews.
- Note: Regular checking of all parts, castings, etc. should be made. If a part is broken or worn, it should be replaced immediately.
- Check to be sure all fittings are tight and that bars and pipes do not move.
- Replace all worn S-hooks. S-hooks must be completely closed. Failure to close S-hooks can result in serious injury to the user. NEVER reuse S-hooks.
- Test for free movement of swing hanger and other moving attached parts.
- Check for worn chains and replace them.
- A soft resilient surface should be placed under all swings extending at least twice the height of the top rail both front and back.

HARDWARE

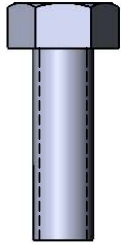

5/16" x 1"
Machine Bolt

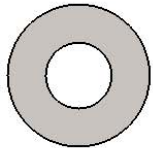

5/16" Washer



5/16" Kep Nut

TOOLS REQUIRED

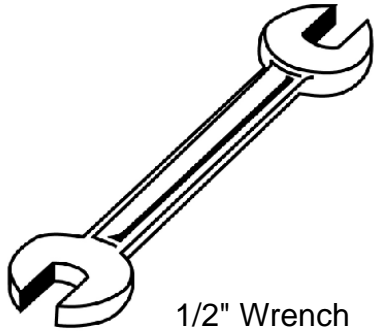

1/2" Wrench

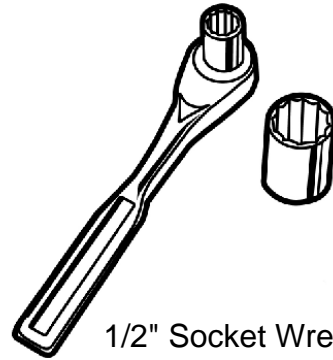

1/2" Socket Wrench

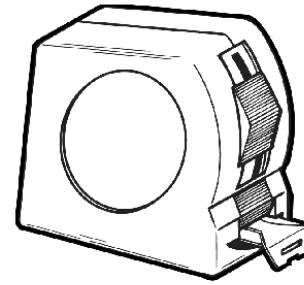

Tape Measure

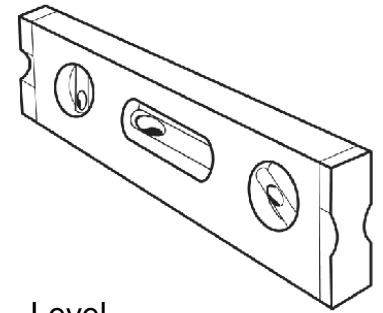

Level

PRODUCT SPECIFICATIONS

940S-P6 INGROUND BENCH WITH BACK

Seats & Back: 11 gauge die formed angle frame 1"x1-7/8" with 3" radius corners. Seat and back plates are fabricated from a 12ga plate. Holes are precision punched at 5/8" diameter. 7 gauge x 1-1/2" flat bar center support and mounting bracket understructure. Electrically MIG welded.

Coating: Oven fused functionalized polyethylene copolymer-based thermoplastic. Fluidized bed coating application with superior mechanical performance, impact resistance and UV-stability.

Frame: 2-3/8" O.D. x 12 gauge pre-galvanized structural steel tubing. Seat/back support is bent over a mandrel through the bend radius producing a wrinkle free bend. Tube ends are pre-galvanized steel capped. Seat mounting points are 7 gauge x 1-1/2" die stamped steel flat bar. All electrically MIG welded.

Frame Coating: Electrostatic powder coated application oven cured.

Hardware: All stainless steel hardware fasteners.

Dimensions: 6' bench inground with back. Seats and back are 12" wide x 72" long. Seat height is 18", seat back height is 35". Total depth of seat with back is 22-1/4".

COMPONENTS

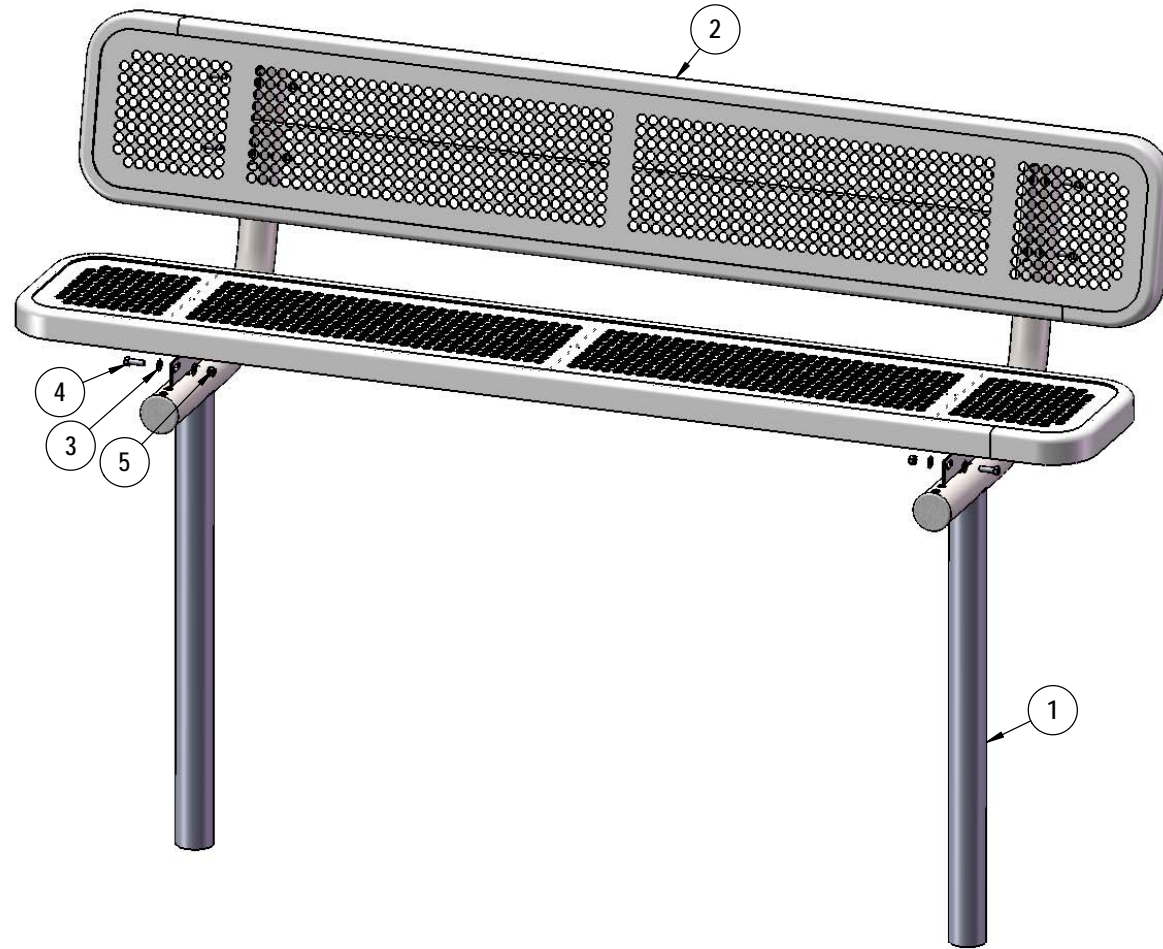

ITEM NO.	PartNo	DESCRIPTION	QTY
1	P-V940S	940 In Ground Leg	2
2	T-P72-S	6' Punched Seat	2
3	33-02-0007	5/16" SS Washer	16
4	33-05-0029	5/16" x 1" Machine Bolt (SS)	8
5	33-03-0012	5/16" Kep Nut (SS)	8

STEP 1

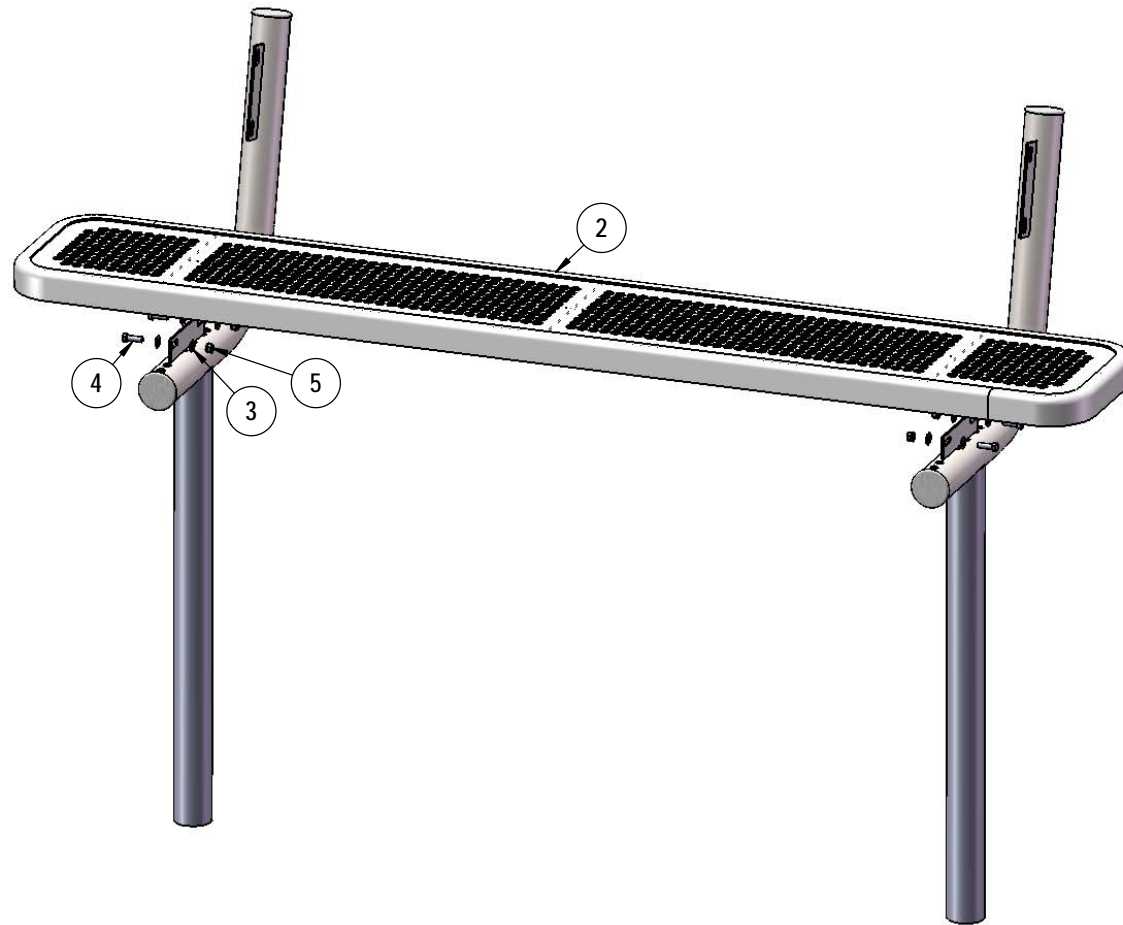

Attach the 6' Punched Seat to the 940 legs using specified hardware.

STEP 2

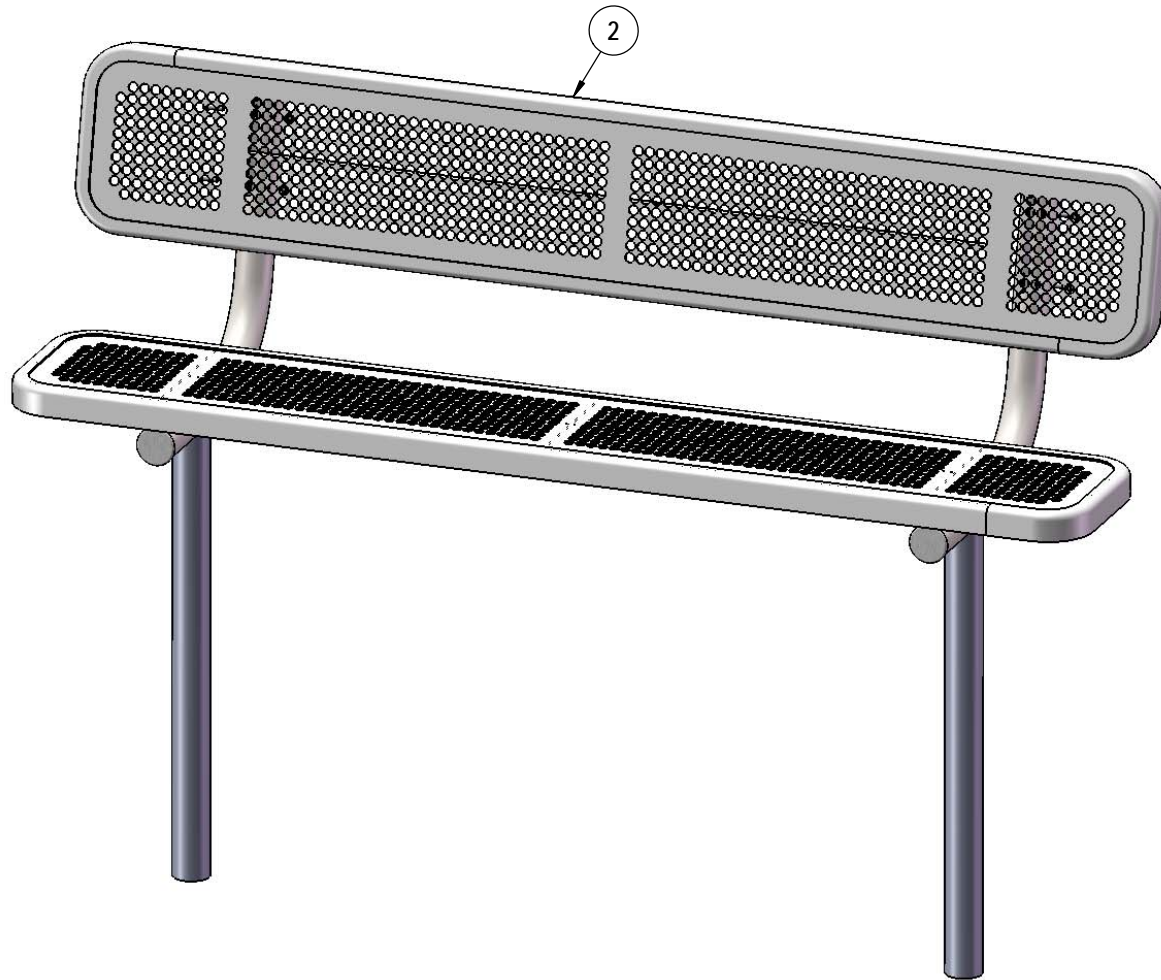

Repeat Step 1 for the back.

FOOTINGS

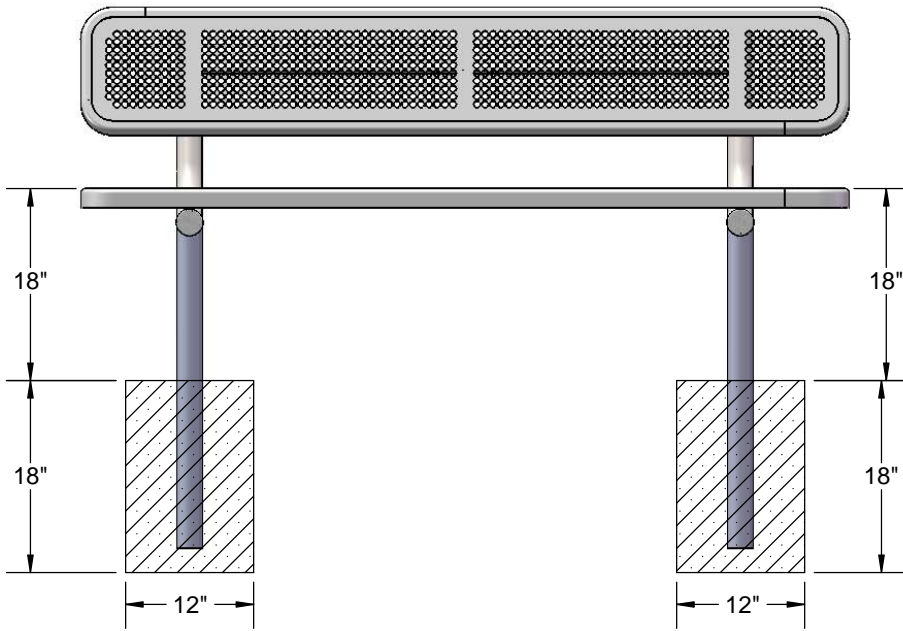
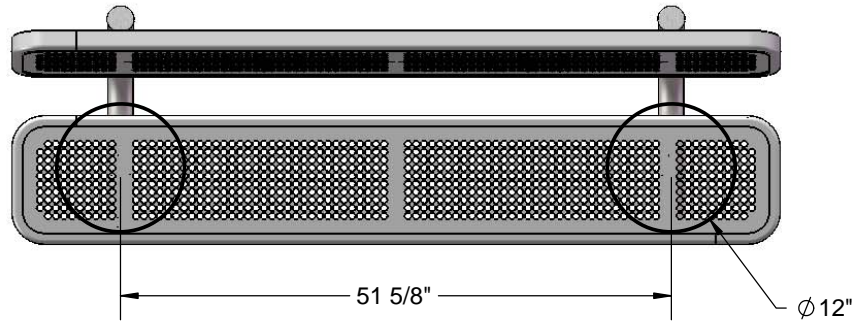

Estimated Required Concrete:
7 - 50lb Bags of Concrete Mix

OVERALL DIMENSIONS

