

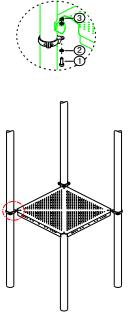









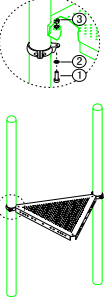
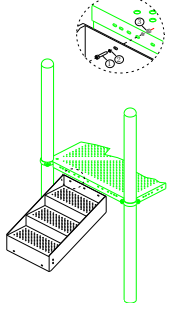
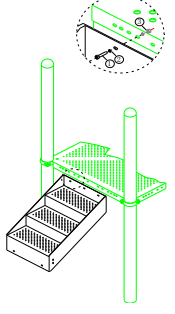
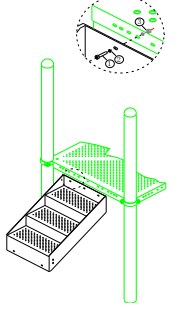
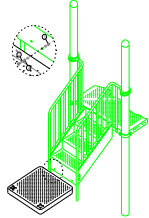
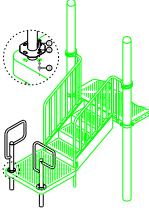
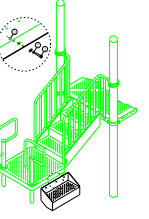
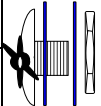
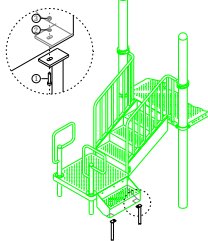

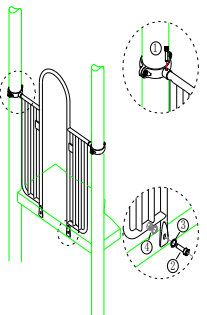
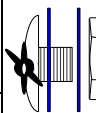
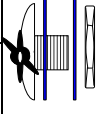
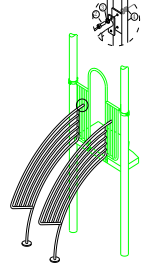
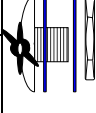
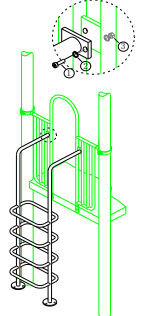
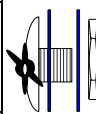
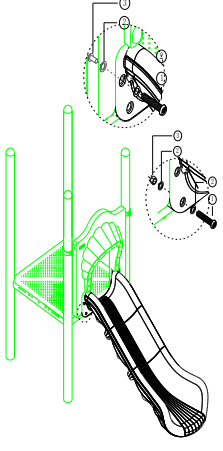
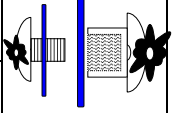
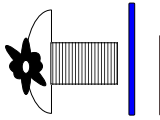
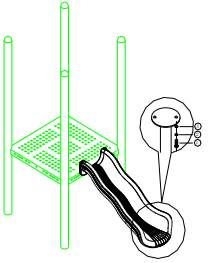
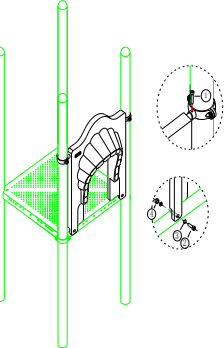
ITEM	ITEM NAME	ITEM NAME	SPECIFICATION	QUANTIT Y	PICTURE	MARK	PICK
1	SQUARE DECK	BOLT	M10*35	4		deck clamp connect with post	
2		WASHER	M10	8			
3		LOCK NUT	M10	4			
1	TRIANGLE DECK	BOLT	M10*35	3		deck clamp connect with post	
2		WASHER	M10	6			
3		LOCK NUT	M10	3			
1	ADA stair	BOLT	M10*25	3		ADA stair connect with deck	
2		WASHER	M10	6			
3		LOCK NUT	M10	3			
	ADA STAIR RAIL	CLAMP		2	pair	ADA stair rail connect with posts and ADA deck	
1		BOLT	M8*30	2			
2		BOLT	M10*25	6			
3		WASHER	M10	12			
4		LOCK NUT	M10	6			

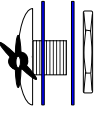
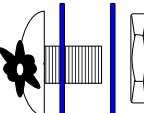
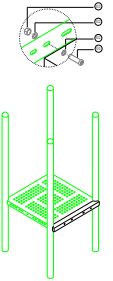
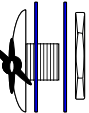
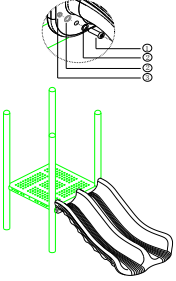
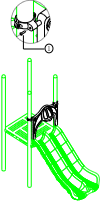
1	ADA STAIR DECK	BOLT	M10*25	4		ADA stair deck connect with ADA stair	
2		WASHER	M10	8			
3		LOCK NUT	M10	4			
1	rail on the ADA deck	BOLT	M10*25	8		rail on the ADA deck connect with the deck	
2		WASHER	M10	16			
3		LOCK NUT	M10	8			
1	ONE STEP FOR ADA	BOLT	M10*25	3		one step for ADA connect with the deck	
2		WASHER	M10	6			
3		LOCK NUT	M10	3			
1	SUPPORT FEET	BOLT	M10*25	4		support feet connect with the step	
2		WASHER	M10	8			
3		LOCK NUT	M10	4			

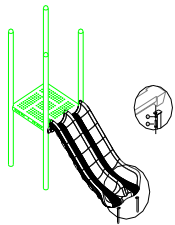
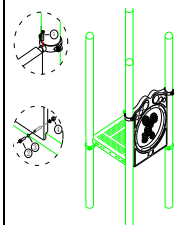
		CLAMP		2	pair		
1	door-shape rail	self tapping screw	M4*25	2		door-shape rail connect with post and deck	
2		BOLT	M10*25	2			
3		WASHER	M10	4			
4		LOCK NUT	M10	2			
1	POD CLIMBER RAIL	BOLT	M10*25	4		POD CLIMBER RAIL CONNECT WITH ARCH ENTRY RAIL	
2		WASHER	M10	8			
3		LOCK NUT	M10	4			
1	120cm square climber	BOLT	M10*25	8		120cm square climber connect with door shape rail	
2		WASHER	M10	16			
3		LOCK NUT	M10	8			
1	SINGLE SLIDE	BOLT	M10*45	2		SINGLE SLIDE CONNECT WITH DECK	
2		WASHER	M10	1			
3		LOCK NUT	M10	2			
4		BOLT	M8*45	2			
5		WASHER	M8	2			
6		WASHER	M12	2			
7		inner hex spiral nut	M12	2			

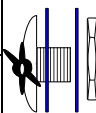
1	support feet	BOLT	M8*20	2		support feet connect with single wave slide	
2		SPRING WASHER	M8	2			
3		WASHER	M8	2			
	SINGLE EXIST PANEL	CLAMP		2	pair	SINGLE EXIST PANEL CONNECT WITH POST AND DECK	
1		self tapping screw	M4*25	2			
2		BOLT	M10*50	2			
3		WASHER	M10	4			
4	LOCK NUT	M10	2				
1	DECK TROUGH	BOLT	M10*25	4		DECK TROUGH connect with DECK	
2		WASHER	M10	8			
3		LOCK NUT	M10	4			
1	DOUBLE STRAIGHT SLIDE	BOLT	M10*45	4		DOUBLE STRAIGHT SLIDE CONNECT WITH DECK	
2		WASHER	M10	8			
3		LOCK NUT	M10	4			
	DOUBLE STRAIGHT SLIDE	90 fastener		2	PAIR	DOUBLE EXIST PANEL CONNECT WITH POST	
1		BOLT	M8*30	2			

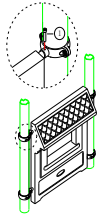
1	SUPPORT FEET	BOLT	M8*20	2		support fear connect with double straight slide	
2		SPRING WASHER	M8	2			
3		WASHER	M8	2			
	GEAR PANEL	CLAMP		2	pair	GEAR PANEL CONNECT WITH POST AND DECK	
1		self tapping screw	M4*25	2			
2		BOLT	M10*50	2			
3		WASHER	M10	4			
4		LOCK NUT	M10	2			

	house panel	CLAMP		4	pair	house panel connect with posts	
1		self tapping screw	M4*25	4			

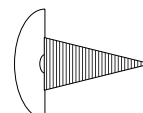
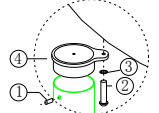
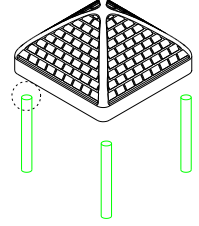
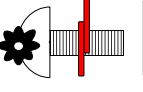
		PLASTIC FIXED		4			
1	QUARREL ROOF	Self-tapping screw	M3*16	12		QUARREL ROOF CONNECT WITH POST	
2		BOLT	M8*20	4			
3		WASHER	M8	4			